



FR20

Fixed Mount Barcode Scanner

User Guide

Disclaimer

© 2015 Fujian Newland Auto-ID Tech. Co., Ltd. All rights reserved.

Please read through the manual carefully before using the product and operate it according to the manual. It is advised that you should keep this manual for future reference.

Do not disassemble the device or remove the seal label from the device. Otherwise, Fujian Newland Auto-ID Tech. Co., Ltd. does not assume responsibility for the warranty or replacement.

All pictures in this manual are for reference only and actual product may differ. Regarding to the product modification and update, Fujian Newland Auto-ID Tech. Co., Ltd. reserves the right to make changes to any software or product to improve reliability, function, or design at any time without notice. Besides, the information contained herein is subject to change without prior notice.

The products depicted in this manual may include software copyrighted by Fujian Newland Auto-ID Tech. Co., Ltd or a third party. The user, corporation or individual, shall not duplicate, in whole or in part, distribute, modify, decompile, disassemble, decode, reverse engineer, rent, transfer or sublicense such software without prior written consent from the copyright holders.

This manual is copyrighted. No part of this publication may be reproduced or used in any form without written permission from Newland.

Fujian Newland Auto-ID Tech. Co., Ltd. reserves the right to make final interpretation of the statement above.

Fujian Newland Auto-ID Tech. Co., Ltd.

3F, Building A, No.1, Rujiang Xi Rd., Mawei, Fuzhou, Fujian, China 350015

<http://www.nlscan.com>

Revision History

Version	Description	Date
V1.0	Initial release.	April 1, 2015

Table of Contents

Chapter 1 Standard Configuration	1
Chapter 2 Optional Configuration	2
Chapter 3 Safety Information	3
Precautions	3
Maintenance	3
Chapter 4 Product Features	4
Chapter 5 Technical Specifications	5
Chapter 6 FR20 Scanner.....	6
Chapter 7 Wiring.....	7
Chapter 8 Scanning Instructions.....	9
Reading a Digital Barcode off Mobile Phone	9
Reading a Barcode Printed on Paper.....	9
Chapter 9 System Settings.....	10
Illumination.....	10
Notification	11
Mute Mode	11
Good Read Beep	11
Good Read Beep Frequency/Duration	12
Scan Mode.....	13
Sense Mode.....	13
Continuous Mode.....	15
Factory Defaults.....	17
Digit Barcodes	18
Save/Cancel Barcodes	20
Chapter 10 RS-232 Interface	21
Chapter 11 USB Interface	22
HID-POS.....	22
USB COM Port Emulation	22

USB HID-KBW	22
Standard Keyboard.....	23
Function Key Mapping.....	23
Emulate ALT+Keypad.....	25
USB Country Keyboard Types	26

Chapter 12 Symbologies 29

Introduction	29
Global Settings	29
Disable All Symbologies	29
Enable All Symbologies.....	29
Enable 1D Symbologies	30
Disable 1D Symbologies	30
Enable 2D Symbologies	30
Disable 2D Symbologies	30
Code 128	31
Restore Factory Defaults.....	31
Enable/Disable Code 128.....	31
UCC/EAN-128 (GS1-128)	32
Restore Factory Defaults.....	32
Enable/Disable UCC/EAN-128.....	32
AIM 128.....	33
Restore Factory Defaults.....	33
Enable/Disable AIM 128	33
EAN-8	34
Restore Factory Defaults.....	34
Enable/Disable EAN-8.....	34
Transmit Check Digit	34
2-Digit Add-On Code	35
5-Digit Add-On Code	35
EAN-8 Extension	36
EAN-13	37
Restore Factory Defaults.....	37
Enable/Disable EAN-13.....	37
Transmit Check Digit	37
2-Digit Add-On Code	38
5-Digit Add-On Code	38

ISSN.....	39
Restore Factory Defaults.....	39
Enable/Disable ISSN.....	39
ISBN.....	40
Restore Factory Defaults.....	40
Enable/Disable ISBN.....	40
Set ISBN Format.....	40
UPC-E.....	41
Restore Factory Defaults.....	41
Enable/Disable UPC-E.....	41
Transmit Check Digit.....	41
2-Digit Add-On Code.....	42
5-Digit Add-On Code.....	42
Transmit System Character.....	43
UPC-E Extension.....	43
UPC-A.....	44
Restore Factory Defaults.....	44
Enable/Disable UPC-A.....	44
Transmit Check Digit.....	44
2-Digit Add-On Code.....	45
5-Digit Add-On Code.....	45
Transmit Preamble Character.....	46
Interleaved 2 of 5.....	47
Restore Factory Defaults.....	47
Enable/Disable Interleaved 2 of 5.....	47
Check Digit Verification.....	48
ITF-6.....	49
Restore Factory Defaults.....	49
Enable/Disable ITF-6.....	49
ITF-14.....	50
Restore Factory Defaults.....	50
Enable/Disable ITF-14.....	50
Matrix 2 of 5 (European Matrix 2 of 5).....	51
Restore Factory Defaults.....	51
Enable/Disable Matrix 2 of 5.....	51
Check Digit Verification.....	52
Industrial 25.....	53

Restore Factory Defaults	53
Enable/Disable Industrial 25	53
Check Digit Verification	54
Standard 25	55
Restore Factory Defaults	55
Enable/Disable Standard 25	55
Check Digit Verification	56
Code 39	57
Restore Factory Defaults	57
Enable/Disable Code 39	57
Transmit Start/Stop Character	57
Enable/Disable Code 39 Full ASCII	58
Check Digit Verification	59
Codabar	60
Restore Factory Defaults	60
Enable/Disable Codabar	60
Check Digit Verification	61
Transmit Start/Stop Character	62
Code 93	63
Restore Factory Defaults	63
Enable/Disable Code 93	63
Check Digit Verification	64
Code 11	65
Restore Factory Defaults	65
Enable/Disable Code 11	65
Check Digit Verification	66
Plessey	67
Restore Factory Defaults	67
Enable/Disable Plessey	67
Check Digit Verification	68
MSI-Plessey	69
Restore Factory Defaults	69
Enable/Disable MSI-Plessey	69
Check Digit Verification	70
RSS-14	71
Restore Factory Defaults	71
Enable/Disable RSS-14	71

Transmit Application Identifier "01".....	71
RSS-Limited.....	72
Restore Factory Defaults.....	72
Enable/Disable RSS- Limited.....	72
Transmit Application Identifier "01".....	72
RSS-Expand.....	73
Restore Factory Defaults.....	73
Enable/Disable RSS-Expand.....	73
PDF417.....	74
Restore Factory Defaults.....	74
Enable/Disable PDF417.....	74
Macro PDF417.....	74
Data Matrix.....	75
Restore Factory Defaults.....	75
Enable/Disable Data Matrix.....	75
Enable/Disable Mirrored DM.....	75
Rectangular Barcodes.....	76
QR Code.....	77
Restore Factory Defaults.....	77
Enable/Disable QR Code.....	77
Micro QR.....	77
Chapter 13 Data Formatting.....	78
AIM ID Prefix.....	78
CODE ID Prefix.....	82
Terminating Character Suffix.....	84
Chapter 14 Troubleshooting.....	85

Chapter 1 Standard Configuration

1. NLS-FR20 Series fixed mount barcode scanner

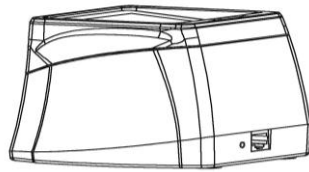

2. USB cable

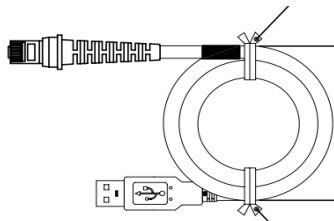

3. Quick Start Guide

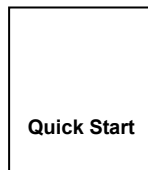

Chapter 2 Optional Configuration

1. RS-232 cable

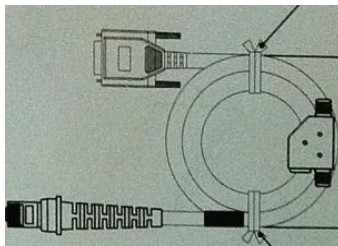

2. 5V power adapter

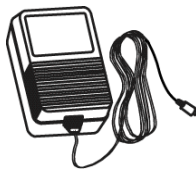

You should retain proof of purchase and ask your dealer for a warranty card.

Note: You should check to make sure that everything on the standard configuration list is present and intact after opening the package. If any contents are damaged or missing, please keep the original package and contact your dealer immediately for after-sale service.

Chapter 3 Safety Information

Precautions

■ Disassembly and retrofit

- Do not disassemble or retrofit the device yourself. Artificial damages caused by failure to observe this precaution are not covered by the warranty.

■ External power supply

- Use only the supplied power adapter. Otherwise there is a risk of damage to the scanner.

■ Abnormal situation

- Keep the scanner away from fire or heat sources. If there is unusual odor, overheating or smoke, immediately cut off the power and disconnect the power adapter, and contact your dealer or Newland customer service center. Continued use in this case may result in fire or electric shock.

■ Drop damage

- If the scanner is damaged due to a drop from high place, immediately cut off the power and contact your dealer or Newland customer service center.

■ Mounting location

- Do not place the scanner on unstable or uneven surfaces.
- Do not expose the scanner to humidity, dust or direct sunlight.

Maintenance

- The scan window should be kept clean using soft cloth or lens cleaning tissue. Do not use detergent to clean it.

- Do not scratch the scan window.

- Sudden temperature drops may cause condensation on the shell which could degrade the performance of the device. If condensation occurs, dry the device before use.

Chapter 4 Product Features

Designed primarily for such applications as electronic tickets/coupons, mobile marketing and office automation, the NLS-FR20 series fixed mount barcode scanner is able to read barcodes from paper and mobile phones.

It boasts the following features:

1. Digital barcode data capture

Capable of reading 1D and 2D barcodes off mobile phones.

2. Printed barcode data capture

Capable of reading 1D and 2D barcodes printed on paper.

3. Swift scanning

Delivers effortless, snappy and accurate reading of barcodes on various mobile phone LCD screens with different contrast ratios, colors and reflectances.

4. Easy to use

Simple configuration by scanning the programming barcodes provided in the user guide.

Chapter 5 Technical Specifications

Processor	IOTC 0370 CHIP
Interface	RS-232 (9.6~115.2Kbps)
	USB 1.1 (HID-KBW, HID-POS)
Image Sensor	640x480 CMOS
Symbologies	2D: PDF417, Data Matrix, QR Code 1D: EAN-13, EAN-8, UPC-A, UPC-E, ISSN, ISBN, Codabar, Code 128, Code 93, ITF-6, ITF-14, Interleaved 2 of 5, Industrial 2 of 5, Standard 2 of 5, Matrix 2 of 5, GS1 Databar (RSS-Expand, RSS-Limited, RSS-14), Code 39, Code 11, MSI-Plessey, Plessey
Scan Mode	Sense mode, Continuous mode
Resolution	10 mil
Light Source	White LED
Scan Window	52mm*69mm
PCS	≥30%
FOV	Diagonal: 68°, Horizontal: 42°, Vertical: 54°
Ambient Light	0 ~ 100,000 LUX
Power Consumption	1W (max.)
Power Adapter	Output: DC5V, 0.5A, Input: AC100~240V, 50~60Hz
Notification	Beep and LED indicator
Dimensions	127.3mm(L) X 111.5mm (W) X 94mm(H)
Weight	300g
Operating Temperature	-10°C to + 50°C
Storage Temperature	-20°C to + 60°C
Humidity	5% - 95% (non-condensing)
Certification	FCC Part15 Class B, CE EMC Class B

Chapter 6 FR20 Scanner

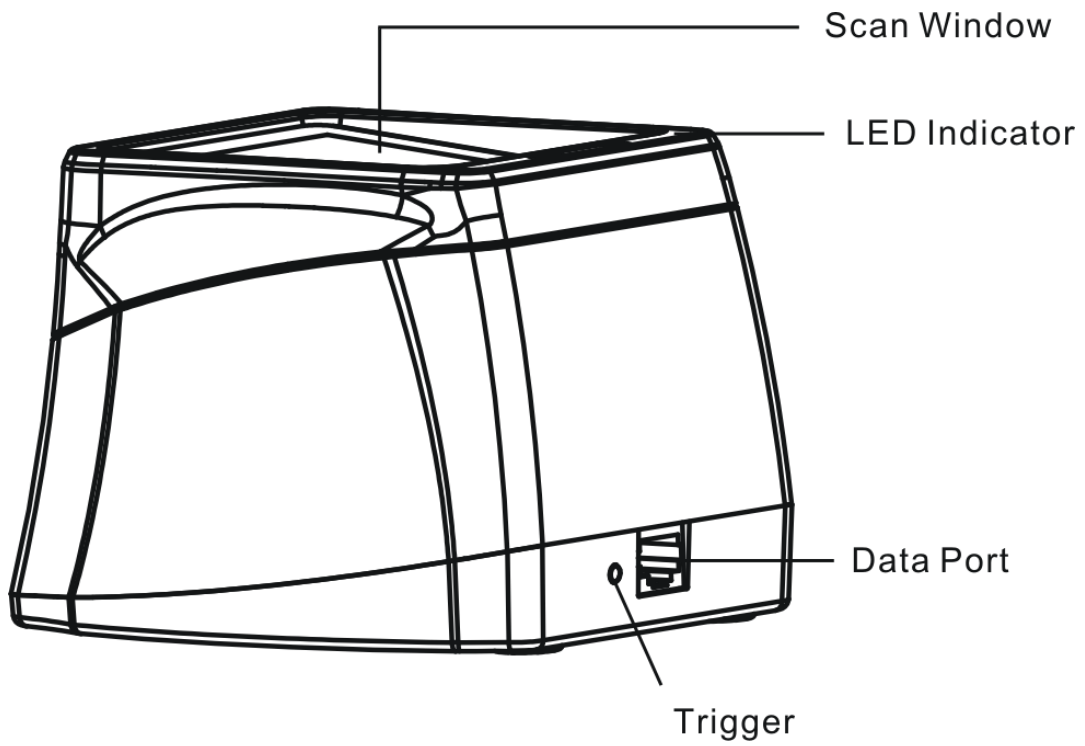

Chapter 7 Wiring

1. If your scanner is equipped with an RS-232 interface:

- 1) Plug the supplied cable's RJ45 connector into the data port on the scanner.
- 2) Plug the cable's RS-232 connector into the RS-232 port on PC.
- 3) Plug the power adapter into the cable's power jack.

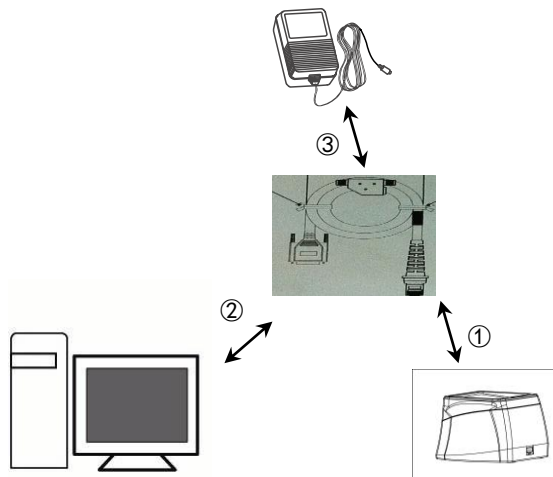

4) Connect the power adapter to a power outlet. After 0.5s the scanner will be powered on (indicator: beep and red LED) and then automatically enter standby mode.

2. If your scanner is equipped with a USB interface:

- 1) Plug the supplied cable's RJ45 connector into the data port on the scanner.
- 2) Plug the cable's USB connector into the USB port on PC.

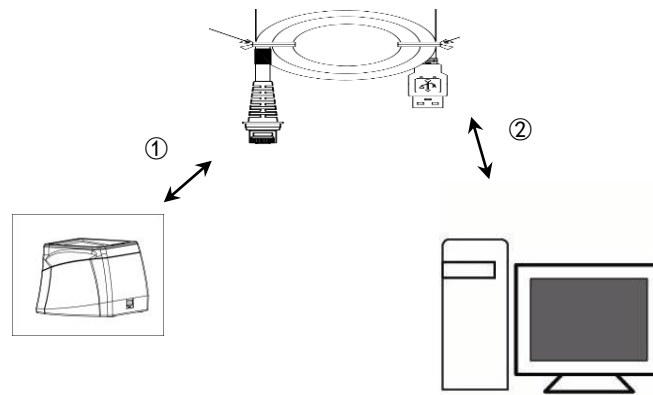

3) After 0.5s the scanner will be powered on (indicator: beep and red LED) and then automatically enter standby mode.

Chapter 8 Scanning Instructions

Reading a Digital Barcode off Mobile Phone

1. Place the mobile phone screen as close as possible to the scan window and present the barcode to the center of the window.
2. For a successful read, the scanner will beep with its LED turning from red to green. After sending the data to the host, it will enter standby mode.

Reading a Barcode Printed on Paper

1. Place the paper as close as possible to the scan window and present the barcode to the center of the window.
2. For a successful read, the scanner will beep with its LED turning from red to green. After sending the data to the host, it will enter standby mode.

Chapter 9 System Settings

Illumination

Always ON: Illumination LED keeps ON after the scanner is powered on.

Normal: Illumination LED is turned on when the scanner is reading barcode.

OFF: Illumination LED is OFF all the time.



W0C0004

** Normal



W0C0000

OFF



W0C000C

Always ON

Notification

Mute Mode

Scanning the **Enable Mute Mode/Disable Mute Mode** can turn off/on all notification beeps.



W400000

Enable Mute Mode



W400040

** Disable Mute Mode

Good Read Beep



W040E04

** Good Read Beep On



W040E00

Good Read Beep Off

Good Read Beep Frequency/Duration



WFF09DA

Low Frequency



WFF094B

** Medium Frequency



WFF0925

High Frequency



WFF0A1F

40ms



WFF0A3E

** 80ms



WFF0A5D

120ms

Scan Mode

Sense Mode

The scanner activates a decode session every time when it detects a change in ambient illumination and meets the requirement of the image stabilization timeout. Decode session continues until barcode is decoded or the decode session timeout expires.

Moreover, a trigger pull can also activate a decode session.



**** Sense Mode**

Decode Session Timeout: This parameter sets the maximum time decode session continues during a scan attempt. It is programmable in 0.1s increments from 0.1s to 25.5s. If it is set to 0, the decode session timeout is infinite.

Image Stabilization Timeout: The scanner waits for the image stabilization timeout to expire before activating a decode session every time it detects a change in ambient illumination. This parameter is programmable in 0.1s increments from 0.0s to 25.5s.



Decode Session Timeout



Image Stabilization Timeout

Example: Set the Image Stabilization Timeout to 5s

1. Scan the **Image Stabilization Timeout** barcode.
2. Scan the numeric barcodes "5" and "0".
3. Scan the **Save** barcode.

Sensitivity: This parameter specifies the degree of acuteness of the scanner’s response to changes in ambient illumination. The higher the sensitivity, the lower requirement in illumination change to trigger the scanner. You can select an appropriate degree of sensitivity that fits the ambient environment.



WFF0305
High Sensitivity



WFF0310
** Medium Sensitivity



WFF0330
Low Sensitivity



M00031A
Custom Sensitivity

Sensitivity levels range from 0 to 255. The smaller the number, the higher the sensitivity.

Example: Set the sensitivity level to 10

1. Scan the **Custom Sensitivity** barcode.
2. Scan the numeric barcodes “1” and “0”.
3. Scan the **Save** barcode.

Continuous Mode

When enabled, the scanner activates decode sessions at user-specified intervals, i.e. the timeout between decodes. Each decode session lasts until barcode is decoded or the decode session timeout expires. To suspend/resume the operation, simply press the trigger.



W030002

Continuous Mode

Decode Session Timeout: This parameter sets the maximum time decode session continues during a scan attempt. It is programmable in 0.1s increments from 0.1s to 25.5s. If it is set to 0, the decode session timeout is infinite.



M00031D

Decode Session Timeout

Example: Set the Decode Session Timeout to 5s

1. Scan the **Decode Session Timeout** barcode.
2. Scan the numeric barcodes “5” and “0”.
3. Scan the **Save** barcode.

Timeout between Decodes: When a decode session ends, next session will not happen until the timeout between decodes expires. It is programmable in 0.1s increments from 0s to 25.5s.



M00031C

Timeout between Decodes

Example: Set the Timeout between Decodes to 5s

1. Scan the **Timeout between Decodes** barcode.
2. Scan the numeric barcodes “5” and “0”.
3. Scan the **Save** barcode.

Factory Defaults

Scanning the following barcode can restore the scanner to the factory defaults.

You may need to reset your scanner when:

1. scanner is not properly configured so that it fails to decode barcodes;
2. you forget previous configuration and want to avoid its impact;
3. functions that are rarely used have been enabled for the time being.



WFFD980

Restore All Factory Defaults

Digit Barcodes

After scanning numeric barcode(s), you need to scan the **Save** barcode to save the data.





A



B



C



D



E



F

Save/Cancel Barcodes

After reading numeric barcode(s), you need to scan the **Save** barcode to save the data. If you scan the wrong digit(s), you can either scan the **Cancel the Last Digit** barcode and then the correct digit, or scan the **Cancel All Digits** barcode and then the digits you want.

For instance, after reading the **Decode Session Timeout** barcode and numeric barcodes “1”, “2” and “3”, you scan:

Cancel the Last Digit: The last digit “3” will be removed.

Cancel All Digits: All digits “123” will be removed.



D 0 0 0 0 1 2

Save



D 0 0 0 0 1 0

Cancel the Last Digit



D 0 0 0 0 1 1

Cancel All Digits

Chapter 10 RS-232 Interface

When the scanner is connected to a host device through its RS-232 interface, serial communication is enabled by default. However, to ensure smooth communication and accuracy of data, you need to set the scanner's communication parameters (including baud rate) to match the host's settings. The default settings of the scanner are 9600bps, no parity check, 8 data bits and 1 stop bit.



WFFD9D3

**** Baud Rate 9600**



WFFD9D0

Baud Rate 1200



WFFD9D1

Baud Rate 2400



WFFD9D2

Baud Rate 4800



WFFD9D4

Baud Rate 14400



WFFD9D5

Baud Rate 19200



WFFD9D6

Baud Rate 38400



WFFD9D7

Baud Rate 57600



WFFD9D8

Baud Rate 115200

Chapter 11 USB Interface

When the scanner is connected to a host device through its USB interface, **USB HID-KBW** is enabled by default. You may switch to **HID-POS** or **USB COM Port Emulation** by scanning the appropriate barcode below.

HID-POS



W030D03

HID-POS

USB COM Port Emulation



W030D02

USB COM Port Emulation

USB HID-KBW



W030D01

**** USB HID-KBW**

Three methods of input are provided for USB HID-KBW: Standard Keyboard, Function Key Mapping, Emulate ALT+Keypad.

Standard Keyboard



**** Standard Keyboard**

Function Key Mapping

When **Function Key Mapping** is enabled, function character (0x00 - 0x1F) are sent as ASCII sequences over the numeric keypad.

1. CTRL Make
2. Press function key (Refer to the **ASCII Function Key Mapping Table** on the following page)
3. CTRL Break



Function Key Mapping

ASCII Function Key Mapping Table

ASCII(HEX)	Function key	ASCII(HEX)	Function key
00	2	10	P
01	A	11	Q
02	B	12	R
03	C	13	S
04	D	14	T
05	E	15	U
06	F	16	V
07	G	17	W
08	H	18	X
09	I	19	Y
0A	J	1A	Z
0B	K	1B	[
0C	L	1C	\
0D	M	1D]
0E	N	1E	6
0F	O	1F	.

Emulate ALT+Keypad

When **Emulate ALT+Keypad** is enabled, any ASCII character (0x00 - 0xFF) is sent over the numeric keypad no matter which keyboard type is selected.

1. ALT Make
2. Enter the number corresponding to the ASCII character on the keypad.
3. ALT Break



W066004

Emulate ALT+Keypad

USB Country Keyboard Types



WFF6B00

**** 1 - U.S.**



WFF6B01

2 - Belgium



WFF6B02

3 - Brazil



WFF6B03

4 - Canada



WFF6B04

5 - Czech



WFF6B05

6 - Denmark



WFF6B06

7 - Finland



WFF6B07

8 - France



WFF6B08

9 - Austria



WFF6B09

10 - Greece



WFF6B0A

11 - Hungary



WFF6B0B

12 - Israel



WFF6B0C

13 - Italy



WFF6B0D

14 - Latin America



WFF6B0E

15 - Netherland



WFF6B0F

16 - Norway



WFF6B10

17 - Poland



WFF6B11

18 - Portugal



WFF6B12

19 - Romania



WFF6B13

20 - Russia



WFF6B15

21 - Slovakia



WFF6B16

22 - Spain



WFF6B17

23 - Sweden



WFF6B18

24 - Switzerland



WFF6B19

25 - Turkey1



WFF6B1A

26 - Turkey 2



WFF6B1B

27 - UK



WFF6B1C

28 - Japan

Chapter 12 Symbologies

Introduction

Every symbology (barcode type) has its own unique attributes. This chapter provides programming barcodes for configuring the scanner so that it can identify various barcode symbologies. It is recommended to disable those that are rarely used to increase the efficiency of the scanner.

Global Settings

Disable All Symbologies

If all symbologies are disabled, the scanner can only identify programming barcodes.



Disable All Symbologies

Enable All Symbologies



Enable All Symbologies

Enable 1D Symbologies



Enable 1D Symbologies

Disable 1D Symbologies



Disable 1D Symbologies

Enable 2D Symbologies



Enable 2D Symbologies

Disable 2D Symbologies



Disable 2D Symbologies

Code 128

Restore Factory Defaults



Restore the Factory Defaults of Code 128

Enable/Disable Code 128



** Enable Code 128



Disable Code 128

UCC/EAN-128 (GS1-128)

Restore Factory Defaults



WFFD991

Restore the Factory Defaults of UCC/EAN-128

Enable/Disable UCC/EAN-128



W011701

** Enable UCC/EAN-128



W011700

Disable UCC/EAN-128

AIM 128

Restore Factory Defaults



WFFD992

Restore the Factory Defaults of AIM 128

Enable/Disable AIM 128



W101610

** Enable AIM 128



W101600

Disable AIM 128

EAN-8

Restore Factory Defaults



WFFD994

Restore the Factory Defaults of EAN-8

Enable/Disable EAN-8



W011301

** Enable EAN-8



W011300

Disable EAN-8

Transmit Check Digit

EAN-8 is 8 digits in length with the last one as its check digit used to verify the integrity of the data.



W041304

** Transmit Check Digit



W041300

Do Not Transmit Check Digit

2-Digit Add-On Code

An EAN-8 barcode can be augmented with a two-digit add-on code to form a new one. In the examples below, the part surrounded by blue dotted line is an EAN-8 barcode while the part circled by red dotted line is add-on code.



Enable 2-Digit Add-On Code



** Disable 2-Digit Add-On Code

5-Digit Add-On Code

An EAN-8 barcode can be augmented with a five-digit add-on code to form a new one. In the examples below, the part surrounded by blue dotted line is an EAN-8 barcode while the part circled by red dotted line is add-on code.



Enable 5-Digit Add-On Code



** Disable 5-Digit Add-On Code

EAN-8 Extension

Disable EAN-8 Zero Extend: Transmit EAN-8 barcodes as is.

Enable EAN-8 Zero Extend: Add five leading zeros to decoded EAN-8 barcodes to extend to 13 digits.



** Disable EAN-8 Zero Extend



Enable EAN-8 Zero Extend

EAN-13

Restore Factory Defaults



Restore the Factory Defaults of EAN-13

Enable/Disable EAN-13



** Enable EAN-13



Disable EAN-13

Transmit Check Digit

EAN-13 is 13 digits in length with the last one as its check digit used to verify the integrity of the data.



** Transmit Check Digit



Do Not Transmit Check Digit

2-Digit Add-On Code

An EAN-13 barcode can be augmented with a two-digit add-on code to form a new one. In the examples below, the part surrounded by blue dotted line is an EAN-8 barcode while the part circled by red dotted line is add-on code.



Enable 2-Digit Add-On Code



** Disable 2-Digit Add-On Code

5-Digit Add-On Code

An EAN-13 barcode can be augmented with a five-digit add-on code to form a new one. In the examples below, the part surrounded by blue dotted line is an EAN-8 barcode while the part circled by red dotted line is add-on code.



Enable 5-Digit Add-On Code



** Disable 5-Digit Add-On Code

ISSN

Restore Factory Defaults



WFFD996

Restore the Factory Defaults of ISSN

Enable/Disable ISSN



W401140

Enable ISSN



W401100

** Disable ISSN

ISBN

Restore Factory Defaults



WFFD997

Restore the Factory Defaults of ISBN

Enable/Disable ISBN



W011201

** Enable ISBN



W011200

Disable ISBN

Set ISBN Format



W041200

** ISBN-13



W041204

ISBN-10

UPC-E

Restore Factory Defaults



WFFD998

Restore the Factory Defaults of UPC-E

Enable/Disable UPC-E



W011501

** Enable UPC-E



W011500

Disable UPC-E

Transmit Check Digit

UPC-E is 8 digits in length with the last one as its check digit used to verify the integrity of the data.



W041504

** Transmit Check Digit



W041500

Do Not Transmit Check Digit

2-Digit Add-On Code

A UPC-E barcode can be augmented with a two-digit add-on code to form a new one. In the examples below, the part surrounded by blue dotted line is a UPC-E barcode while the part circled by red dotted line is add-on code.



Enable 2-Digit Add-On Code



** Disable 2-Digit Add-On Code

5-Digit Add-On Code

A UPC-E barcode can be augmented with a five-digit add-on code to form a new one. In the examples below, the part surrounded by blue dotted line is a UPC-E barcode while the part circled by red dotted line is add-on code.



Enable 5-Digit Add-On Code



** Disable 5-Digit Add-On Code

Transmit System Character



Transmit System Character "0"



** Do Not Transmit System Character "0"

UPC-E Extension

Disable UPC-E Extend: Transmit UPC-E barcodes as is.

Enable UPC-E Extend: Extend UPC-E barcodes to make them compatible in length to UPC-A.



Enable UPC-E Extend



** Disable UPC-E Extend

UPC-A

Restore Factory Defaults



WFFD999

Restore the Factory Defaults of UPC-A

Enable/Disable UPC-A



W011401

** Enable UPC-A



W011400

Disable UPC-A

Transmit Check Digit

UPC-A is 13 digits in length with the last one as its check digit used to verify the integrity of the data.



W041404

** Transmit Check Digit



W041400

Do Not Transmit Check Digit

2-Digit Add-On Code

A UPC-A barcode can be augmented with a two-digit add-on code to form a new one. In the examples below, the part surrounded by blue dotted line is a UPC-E barcode while the part circled by red dotted line is add-on code.



Enable 2-Digit Add-On Code



** Disable 2-Digit Add-On Code

5-Digit Add-On Code

A UPC-A barcode can be augmented with a five-digit add-on code to form a new one. In the examples below, the part surrounded by blue dotted line is a UPC-E barcode while the part circled by red dotted line is add-on code.



Enable 5-Digit Add-On Code



** Disable 5-Digit Add-On Code

Transmit Preamble Character



Transmit Preamble Character "0"



** Do Not Transmit Preamble Character "0"

Interleaved 2 of 5

Restore Factory Defaults



WFFD99A

Restore the Factory Defaults of Interleaved 2 of 5

Enable/Disable Interleaved 2 of 5



W011801

** Enable Interleaved 2 of 5



W011800

Disable Interleaved 2 of 5

Check Digit Verification

A check digit is optional for Interleaved 2 of 5 and can be added as the last digit. It is a calculated value used to verify the integrity of the data.

Disable: The scanner transmits Interleaved 2 of 5 barcodes as is.

Do Not Transmit Check Digit after Verification: The scanner checks the integrity of all Interleaved 2 of 5 barcodes to verify that the data complies with the check digit algorithm. Barcodes passing the check will be transmitted except the last digit, whereas those failing it will not be transmitted.

Transmit Check Digit after Verification: The scanner checks the integrity of all Interleaved 2 of 5 barcodes to verify that the data complies with the check digit algorithm. Barcodes passing the check will be transmitted, whereas those failing it will not be transmitted.



W0C1800

** Disable



W0C1804

Do Not Transmit Check Digit after Verification



W0C180C

Transmit Check Digit after Verification

ITF-6

Restore Factory Defaults



Restore the Factory Defaults of ITF-6

Enable/Disable ITF-6



** Disable ITF-6



Enable ITF-6 But Do Not Transmit Check Digit



Enable ITF-6 and Transmit Check Digit

ITF-14

Restore Factory Defaults



WFFD99C

Restore the Factory Defaults of ITF-14

Enable/Disable ITF-14



W201800

Disable ITF-14



WA01820

Enable ITF-14 But Do Not Transmit Check Digit



WA018A0

** Enable ITF-14 and Transmit Check Digit

Matrix 2 of 5 (European Matrix 2 of 5)

Restore Factory Defaults



WFFD99F

Restore the Factory Defaults of Matrix 2 of 5

Enable/Disable Matrix 2 of 5



W011A01

** Enable Matrix 2 of 5



W011A00

Disable Matrix 2 of 5

Check Digit Verification

A check digit is optional for Matrix 2 of 5 and can be added as the last digit. It is a calculated value used to verify the integrity of the data.

Disable: The scanner transmits Matrix 2 of 5 barcodes as is.

Do Not Transmit Check Digit After Verification: The scanner checks the integrity of all Matrix 2 of 5 barcodes to verify that the data complies with the check digit algorithm. Barcodes passing the check will be transmitted except the last digit, whereas those failing it will not be transmitted.

Transmit Check Digit After Verification: The scanner checks the integrity of all Matrix 2 of 5 barcodes to verify that the data complies with the check digit algorithm. Barcodes passing the check will be transmitted, whereas those failing it will not be transmitted.



W041A00

**** Disable**



W0C1A04

Do Not Transmit Check Digit after Verification



W0C1A0C

Transmit Check Digit after Verification

Industrial 25

Restore Factory Defaults



WFFD9A0

Restore the Factory Defaults of Industrial 25

Enable/Disable Industrial 25



W081908

** Enable Industrial 25



W081900

Disable Industrial 25

Check Digit Verification

A check digit is optional for Industrial 25 and can be added as the last digit. It is a calculated value used to verify the integrity of the data.

Disable: The scanner transmits Industrial 25 barcodes as is.

Do Not Transmit Check Digit after Verification: The scanner checks the integrity of all Industrial 25 barcodes to verify that the data complies with the check digit algorithm. Barcodes passing the check will be transmitted except the last digit, whereas those failing it will not be transmitted.

Transmit Check Digit after Verification: The scanner checks the integrity of all Industrial 25 barcodes to verify that the data complies with the check digit algorithm. Barcodes passing the check will be transmitted, whereas those failing it will not be transmitted.



W201900

**** Disable**



W601920

Do Not Transmit Check Digit after Verification



W601960

Transmit Check Digit after Verification

Standard 25

Restore Factory Defaults



WFFD9A1

Restore the Factory Defaults of Standard 25

Enable/Disable Standard 25



W101A10

** Enable Standard 25



W101A00

Disable Standard 25

Check Digit Verification

A check digit is optional for Standard 25 and can be added as the last digit. It is a calculated value used to verify the integrity of the data.

Disable: The scanner transmits Standard 25 barcodes as is.

Do Not Transmit Check Digit after Verification: The scanner checks the integrity of all Standard 25 barcodes to verify that the data complies with the check digit algorithm. Barcodes passing the check will be transmitted except the last digit, whereas those failing it will not be transmitted.

Transmit Check Digit after Verification: The scanner checks the integrity of all Standard 25 barcodes to verify that the data complies with the check digit algorithm. Barcodes passing the check will be transmitted, whereas those failing it will not be transmitted.



W401A00

**** Disable**



WC01A40

Do Not Transmit Check Digit after Verification



WC01AC0

Transmit Check Digit after Verification

Code 39

Restore Factory Defaults



WFFD9A2

Restore the Factory Defaults of Code 39

Enable/Disable Code 39



W011C01

** Enable Code 39



W011C00

Disable Code 39

Transmit Start/Stop Character

Code 39 uses an asterisk (*) for both the start and the stop characters. You can choose whether or not to transmit the start/stop characters by scanning the appropriate barcode below.



W041C04

Transmit Start/Stop Character



W041C00

** Do Not Transmit Start/Stop Character

Enable/Disable Code 39 Full ASCII

The scanner can be configured to identify all ASCII characters by scanning the appropriate barcode below.



W201C00

**** Disable Code 39 Full ASCII**



W201C20

Enable Code 39 Full ASCII

Check Digit Verification

A check digit is optional for Code 39 and can be added as the last digit. It is a calculated value used to verify the integrity of the data.

Disable: The scanner transmits Code 39 barcodes as is.

Do Not Transmit Check Digit after Verification: The scanner checks the integrity of all Code 39 barcodes to verify that the data complies with the check digit algorithm. Barcodes passing the check will be transmitted except the last digit, whereas those failing it will not be transmitted.

Transmit Check Digit after Verification: The scanner checks the integrity of all Code 39 barcodes to verify that the data complies with the check digit algorithm. Barcodes passing the check will be transmitted, whereas those failing it will not be transmitted.



W081C00

**** Disable**



W181C08

Do Not Transmit Check Digit after Verification



W181C18

Transmit Check Digit after Verification

Codabar

Restore Factory Defaults



WFFD9A3

Restore the Factory Defaults of Codabar

Enable/Disable Codabar



W011E01

** Enable Codabar



W011E00

Disable Codabar

Check Digit Verification

Check digits are optional for Codabar and can be added as the last two digits, which are calculated values used to verify the integrity of the data.

Disable: The scanner transmits Codabar barcodes as is.

Do Not Transmit Check Digit after Verification: The scanner checks the integrity of all Codabar barcodes to verify that the data complies with the check digit algorithm. Barcodes passing the checks will be transmitted except the last two digits, whereas those failing them will not be transmitted.

Transmit Check Digit after Verification: The scanner checks the integrity of all Codabar barcodes to verify that the data complies with the check digit algorithm. Barcodes passing the checks will be transmitted, whereas those failing them will not be transmitted.



W101E00

**** Disable**



W301E10

Do Not Transmit Check Digit after Verification



W301E30

Transmit Check Digit after Verification

Transmit Start/Stop Character



W021E00

Do Not Transmit Start/Stop Character



W021E02

**** Transmit Start/Stop Character**



W0C1E00

**** ABCD/ABCD as the Start/Stop Character**



W0C1E04

ABCD/TN*E as the Start/Stop Character



W0C1E08

abcd/abcd as the Start/Stop Character



W0C1E0C

abcd/tn*e as the Start/Stop Character

Code 93

Restore Factory Defaults



WFFD9A4

Restore the Factory Defaults of Code 93

Enable/Disable Code 93



W081208

** Enable Code 93



W081200

Disable Code 93

Check Digit Verification

Check digits are optional for Code 93 and can be added as the last two digits, which are calculated values used to verify the integrity of the data.

Disable: The scanner transmits Code 93 barcodes as is.

Do Not Transmit Check Digit after Verification: The scanner checks the integrity of all Code 93 barcodes to verify that the data complies with the check digit algorithm. Barcodes passing the checks will be transmitted except the last two digits, whereas those failing them will not be transmitted.

Transmit Check Digit after Verification: The scanner checks the integrity of all Code 93 barcodes to verify that the data complies with the check digit algorithm. Barcodes passing the checks will be transmitted, whereas those failing them will not be transmitted.



W201200

Disable



W601220

**** Do Not Transmit Check Digit after Verification**



W601260

Transmit Check Digit after Verification

Code 11

Restore Factory Defaults



WFFD9A5

Restore the Factory Defaults of Code 11

Enable/Disable Code 11



W011D01

** Enable Code 11



W011D00

Disable Code 11

Check Digit Verification

Check digits are optional for Code 11 and can be added as the last one or two digits, which are calculated values used to verify the integrity of the data.

If the **Disable** option is enabled, the scanner transmits Code 11 barcodes as is.



W1C1D00

Disable



W1C1D04

**** One Check Digit, MOD11**



W1C1D08

Two Check Digits, MOD11/MOD11



W1C1D0C

Two Check Digits, MOD11/MOD9



W1C1D10

One Check Digit, MOD11 (Len <= 11)
Two Check Digits, MOD11/MOD11 (Len > 11)



W1C1D14

One Check Digit, MOD11 (Len <= 11)
Two Check Digits, MOD11/MOD9 (Len > 11)



W201D00

Do Not Transmit Check Digit



W201D20

**** Transmit Check Digit**

Plessey

Restore Factory Defaults



WFFD9A6

Restore the Factory Defaults of Plessey

Enable/Disable Plessey



W011F01

** Enable Plessey



W011F00

Disable Plessey

Check Digit Verification

Check digits are optional for Plessey and can be added as the last one or two digits, which are calculated values used to verify the integrity of the data.

Disable: The scanner transmits Plessey barcodes as is.

Do Not Transmit Check Digit after Verification: The scanner checks the integrity of all Plessey barcodes to verify that the data complies with the check digit algorithm. Barcodes passing the checks will be transmitted except the last two digits, whereas those failing them will not be transmitted.

Transmit Check Digit after Verification: The scanner checks the integrity of all Plessey barcodes to verify that the data complies with the check digit algorithm. Barcodes passing the checks will be transmitted, whereas those failing them will not be transmitted.



Disable



** Do Not Transmit Check Digit after Verification



Transmit Check Digit after Verification

MSI-Plessey

Restore Factory Defaults



WFFD9A7

Restore the Factory Defaults of MSI-Plessey

Enable/Disable MSI-Plessey



W081F08

** Enable MSI-Plessey



W081F00

Disable MSI-Plessey

Check Digit Verification

Check digits are optional for MSI-Plessey and can be added as the last one or two digits, which are calculated values used to verify the integrity of the data.

If the **Disable** option is enabled, the scanner transmits MSI-Plessey barcodes as is.



W301F00

Disable



W301F10

** One Check Digit, MOD10



W301F20

Two Check Digits, MOD10/MOD10



W301F30

Two Check Digits, MOD10/MOD11



W401F00

Do Not Transmit Check Digit



W401F40

** Transmit Check Digit

RSS-14

Restore Factory Defaults



WFFD9A8

Restore the Factory Defaults of RSS-14

Enable/Disable RSS-14



W011B01

** Enable RSS-14



W011B00

Disable RSS-14

Transmit Application Identifier "01"



W041B04

** Transmit Application Identifier "01"



W041B00

Do Not Transmit Application Identifier "01"

RSS-Limited

Restore Factory Defaults



WFFD9A9

Restore the Factory Defaults of RSS-Limited

Enable/Disable RSS- Limited



W081B08

** Enable RSS-Limited



W081B00

Disable RSS-Limited

Transmit Application Identifier “01”



W201B20

** Transmit Application Identifier “01”



W201B00

Do Not Transmit Application Identifier “01”

RSS-Expand

Restore Factory Defaults



WFFD9AA

Restore the Factory Defaults of RSS-Expand

Enable/Disable RSS-Expand



W401B40

** Enable RSS-Expand



W401B00

Disable RSS-Expand

PDF417

Restore Factory Defaults



WFFD9B0

Restore the Factory Defaults of PDF417

Enable/Disable PDF417



W010C01

** Enable PDF417



W010C00

Disable PDF417

Macro PDF417



W100C10

Enable Macro PDF417



W100C00

** Disable Macro PDF417

Data Matrix

Restore Factory Defaults



Restore the Factory Defaults of Data Matrix

Enable/Disable Data Matrix



** Enable Data Matrix



Disable Data Matrix

Enable/Disable Mirrored DM



Enable Mirrored DM



** Disable Mirrored DM

Rectangular Barcodes

Data Matrix has two formats:

Square barcodes having the same amount of modules in length and width: 10*10, 12*12.... 144*144.

Rectangular barcodes having different amounts of models in length and width: 6*16, 6*14... 14*22.



**** Decode Rectangular Barcodes**



Do Not Decode Rectangular Barcodes

QR Code

Restore Factory Defaults



WFFD9B2

Restore the Factory Defaults of QR Code

Enable/Disable QR Code



W800D80

** Enable QR Code



W800D00

Disable QR Code

Micro QR

This parameter is valid only when QR Code is enabled.



W049904

** Enable Micro QR



W049900

Disable Micro QR

Chapter 13 Data Formatting

AIM ID Prefix

AIM (Automatic Identification Manufacturers) IDs define symbology identifiers and data carrier identifiers. For the details, see the **AIM ID Table**. If AIM ID prefix is enabled, the engine will add the symbology identifier before the scanned data after decoding.



**** Disable AIM ID Prefix**



Enable AIM ID Prefix

AIM ID Table

Symbology	AIM ID	Remark
Code 128]C0	Standard Code 128
UCC/EAN 128 (GS1-128)]C1	FNC1 is the character right after the start character
AIM 128]C2	FNC1 is the 2nd character after the start character
EAN-8]E4	Standard EAN-8
]E4....]E1...	EAN-8 + 2-Digit Add-On Code
]E4....]E2...	EAN-8 + 5-Digit Add-On Code
EAN-13]E0	Standard EAN-13
]E3	EAN-13 + 2/5-Digit Add-On Code
ISSN]X5	
ISBN]X4	
UPC-E]E0	Standard UPC-E
]E3	UPC-E + 2/5-Digit Add-On Code
UPC-A]E0	Standard UPC-A
]E3	UPC-A + 2/5-Digit Add-On Code
Interleaved 2 of 5]I0	No check digit verification
]I1	Transmit check digit after verification
]I3	Do not transmit check digit after verification
ITF-6]I1	Transmit check digit
]I3	Do not transmit check digit
ITF-14]I1	Transmit check digit
]I3	Do not transmit check digit
Matrix 2 of 5]X1	No check digit verification
]X2	Transmit check digit after verification
]X3	Do not transmit check digit after verification
Industrial 25]S0	Not specified
Standard 25]R0	No check digit verification
]R8	One check digit, MOD 7; do not transmit check digit
]R9	One check digit, MOD 7; transmit check digit

Symbology	AIM ID	Remark
Code 39	JA0	Transmit barcodes as is; Full ASCII disabled; no check digit verification
	JA1	One check digit, MOD 43; transmit check digit
	JA3	One check digit, MOD 43; do not transmit check digit
	JA4	Full ASCII enabled; no check digit verification
	JA5	Full ASCII enabled; MOD43; transmit check digit
	JA7	Full ASCII enabled; MOD43; do not transmit check digit
Codabar	JF0	Standard Codabar
	JF1	ABC Codabar
	JF2	Transmit check digit after verification
	JF4	Do not transmit check digit after verification
Code 93	JG0	Not specified
Code 11	JH0	One check digit, MOD11; transmit check digit
	JH1	Two check digits, MOD11/MOD11; transmit check digit
	JH3	Do not transmit check digit after verification
	JH8	Two check digits, MOD11/MOD9; transmit check digit
	JH9	No check digit verification
Plessey	JP0	Not specified
MSI-Plessey	JM0	One check digit, MOD10; transmit check digit
	JM1	One check digit, MOD10; do not transmit check digit
	JM7	Two check digits, MOD10 /MOD11; do not transmit check digit
	JM8	Two check digits, MOD10 /MOD11; transmit check digit
	JM9	No check digit verification
RSS-14 RSS-Limited RSS-Expand	Je0	Standard
	Je1	User-defined
	Je2	User-defined
	Je3	User-defined
PDF417	JL0	Comply with 1994 PDF417 specifications
Data Matrix	jd0	ECC 000 - 140
	jd1	ECC 200
	jd2	ECC 200; FNC1 is the 1st or 5th character after the start character

Symbology	AIM ID	Remark
]d3	ECC 200; FNC1 is the 2nd or 6th character after the start character
]d4	ECC 200, ECI protocol supported
]d5	ECC 200; FNC1 is the 1st or 5th character after the start character; ECI supported
]d6	ECC 200; FNC1 is the 2nd or 6th character after the start character; ECI supported
QR Code]Q0	QR1 (comply with AIM ISS 97-001 specifications)
]Q1	QR2 (2005 symbol), ECI protocol not supported
]Q2	QR2 (2005 symbol), ECI protocol supported
]Q3	QR2 (2005 symbol), ECI protocol not supported; FNC1 is the character right after the start character
]Q4	QR2 (2005 symbol), ECI protocol supported; FNC1 is the character right after the start character
]Q5	QR2 (2005 symbol), ECI protocol not supported; FNC1 is the 2nd character right after the start character
]Q6	QR2 (2005 symbol), ECI protocol supported; FNC1 is the 2nd character right after the start character

CODE ID Prefix

Code ID can also be used to identify barcode type. For the details, see the **CODE ID Table**.



W800200

**** Disable CODE ID Prefix**



W800280

Enable CODE ID Prefix

You can choose to transmit original CODE ID or visible CODE ID by scanning the appropriate barcode below.



W018A00

**** Original CODE ID**



W018A01

Visible CODE ID

CODE ID Table

Symbology	Original Code ID	Visible Code ID
Code 128 FNC3	0x01	A(0x41)
Code 128	0x02	B(0x42)
UCC/EAN 128	0x03	C(0x43)
EAN-8	0x04	D(0x44)
EAN-13	0x05	E(0x45)
UPC-E	0x06	F(0x46)
UPC-A	0x07	G(0x47)
Interleaved 2 of 5	0x08	H(0x48)
ITF-14	0x09	I(0x49)
ITF-6	0x0A	J(0x4A)
Code 39	0x0D	M(0x4D)
Codabar	0x0F	O(0x4F)
Standard 25	0x10	P(0x50)
Code 93	0x11	Q(0x51)
AIM 128	0x15	U(0x55)
MSI-Plessey	0x16	V(0x56)
ISBN	0x17	W(0x57)
Industrial 25	0x18	X(0x58)
Matrix 2 of 5	0x19	Y(0x59)
RSS-14	0x1A	Z(0x5A)
RSS-Limited	0x1B	[(0x5B)
RSS-Expand	0x1C	\(0x5C)
Code 11	0x1D](0x5D)
Plessey	0x1E	^(0x5E)
ISSN	0x1F	_(0x5F)
PDF417	0x20	`(0x60)
QR Code	0x21	a(0x61)
Data Matrix	0x23	c(0x63)

Terminating Character Suffix

A terminating character such as carriage return (CR) or carriage return/line feed pair (CRLF) or horizontal tab (TAB) can be used to mark the end of data.



W616000

Disable Terminating Character Suffix



W616001

Append CR



W616021

** Append CRLF



W616041

Append TAB

Chapter 14 Troubleshooting

Problem	Solution
Does not respond to input.	Disconnect the power adapter and then reconnect it.
Scanned data is not displayed on the host.	Ensure the scanner's communication parameters (such as baud rate, interface) match the host's settings.
Cannot read barcodes.	<ol style="list-style-type: none">1. Follow the scanning instructions in this manual to scan barcode.2. Ensure the barcode type is enabled.3. Ensure the barcode is not defaced. Wrinkled, soiled or torn barcodes might be unreadable.



Newland EMEA

+31 (0) 345 87 00 33
info@newland-id.com

Newland D-A-CH

+49 (0) 294 298 76758
info@newland-id.de

Newland UK

+44 (0) 1442 212 020
sales@newland-id.co.uk

Newland Nordic

+46 (0) 708 847 767
nordic@newland-id.com

Newland Ibérica

+34 (0) 93 303 74 66
info@newland-id.es

Newland France

+31 (0) 345 87 00 33
france@newland-id.com

Newland Middle East

+31 (0) 345 87 00 33
middleeast@newland-id.com

Newland South Africa

+27 (0) 11 553 8010
info@newland-id.co.za

Newland Italy

+39 (0) 342 056 2227
italy@newland-id.com

Newland Russia

+31 (0) 345 87 00 33
russia@newland-id.com